

ETT Ábrák (Készítette: Denke Ákos, TT10WV, deeagle001@gmail.com)

Csak azok amelyek érzésem szerint lehetnek vizsgában, zh-ban.

Teljes forma:

1.

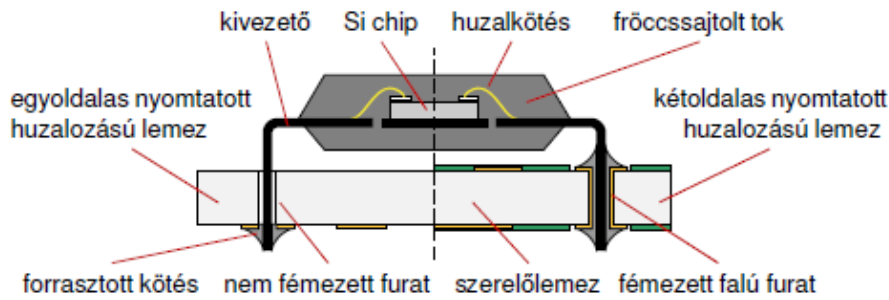

Ellenállás

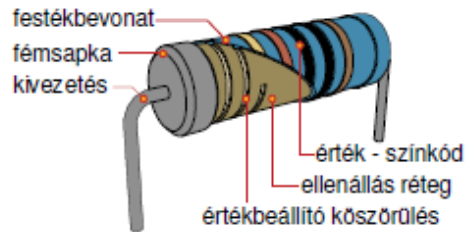

Kondenzátor

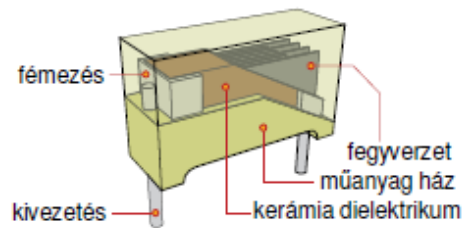

Tekercs

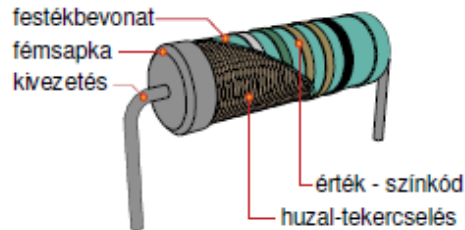

Dióda

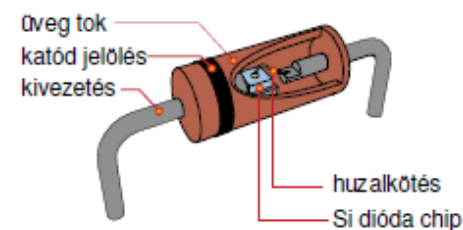

Felületszerelt kondenzátor

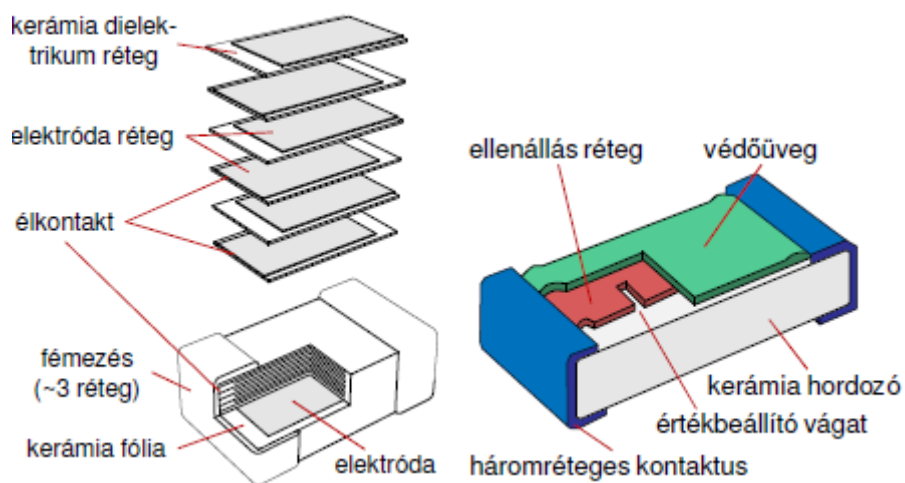

BGA

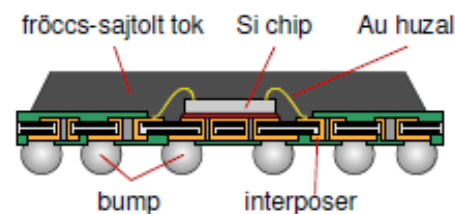

FC-BGA

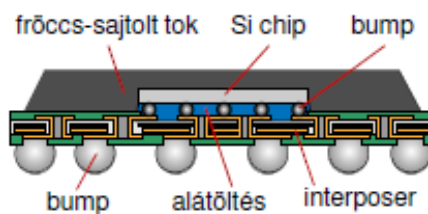

Idő/nyomás elvű

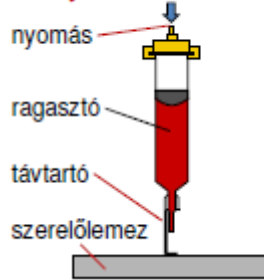

Csavarorsós

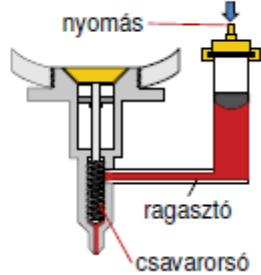

Sugaras cseppadagoló

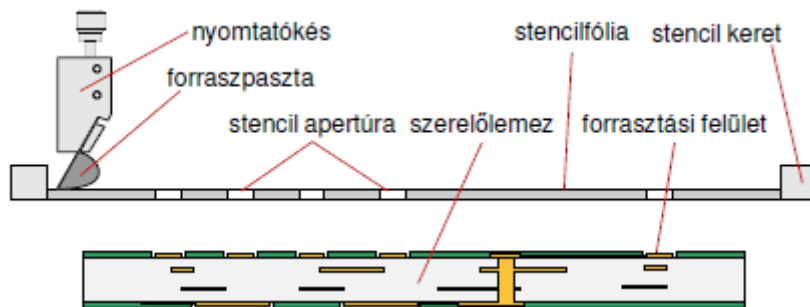
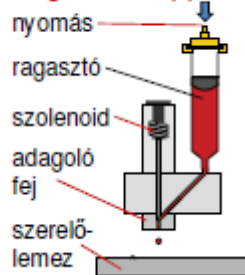

Alumínium keret

Feszítő szitaszövet (rozsdamentes acél)

Stencilfólia - rozsdamentes acél - nikkell

Nyomatási kép, apertúrák

Illesztési segédábra (fiduciális jel)

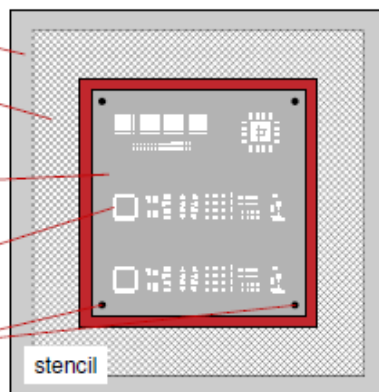

beültetőfej

cserélhető pipetta

alkatrészek

szerelőlemez

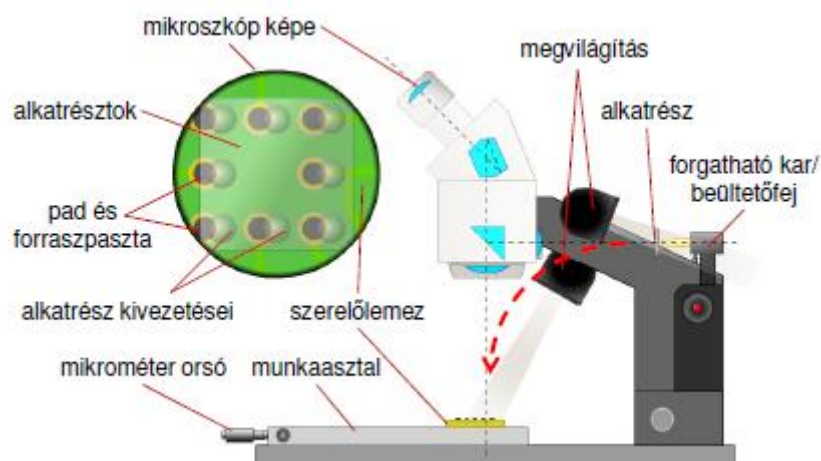
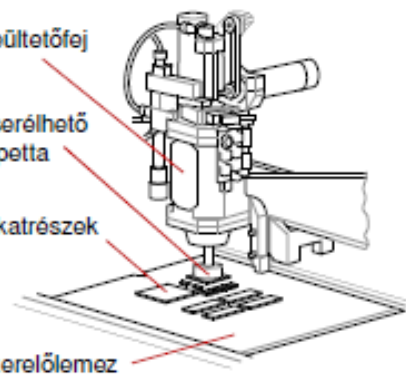

stencil apertúra hátoldali dombormarás forraszpaszta

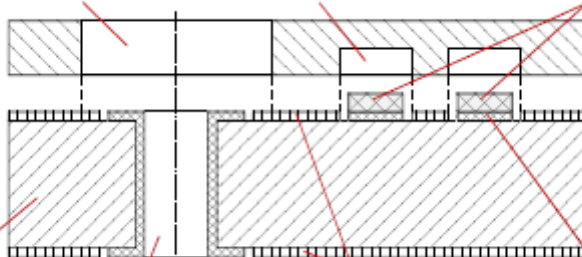

szerelőlemez fémezett falú furat forrasztásgátló maszk pad SMD alkatrészhez

2.

Chip+huzalkötés (Chip-and-wire)

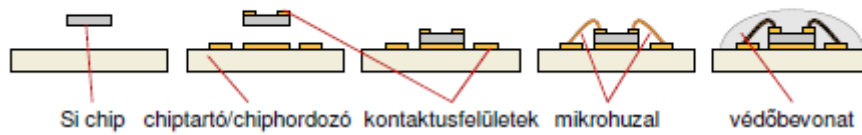

TAB (Tape Automated Bonding)

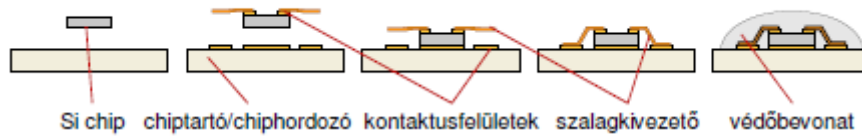

Flip-chip

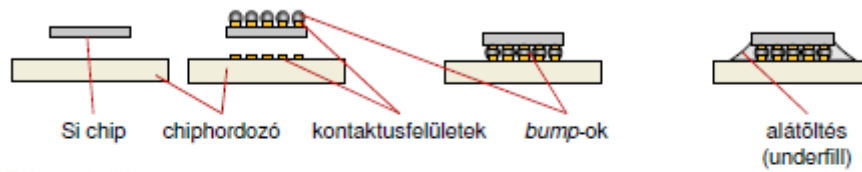

Tokozott chip

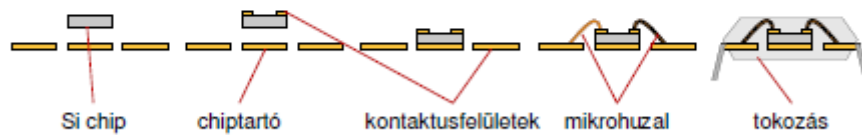

1. chip és hordozó
2. kontaktusfelület kialakítása
3. beültetés és chipprőgítés
4. elektromos kontaktálás
5. védőbevonat /tokozás

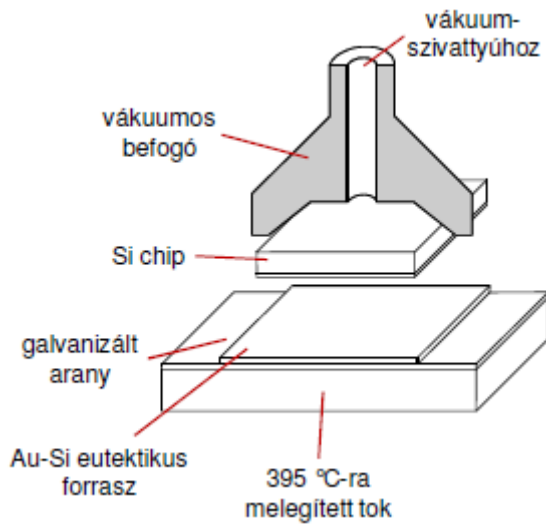

Fémüveg tok

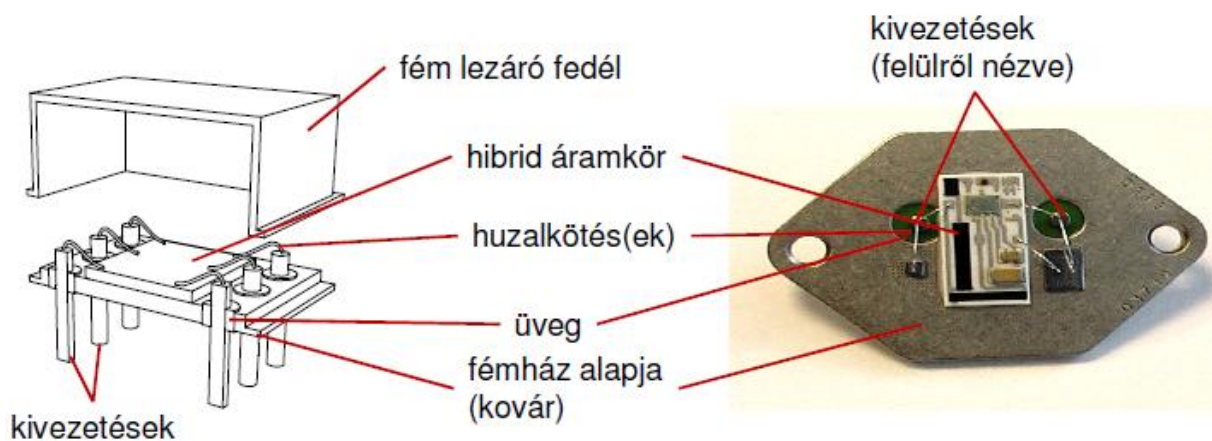

Kerámia tok

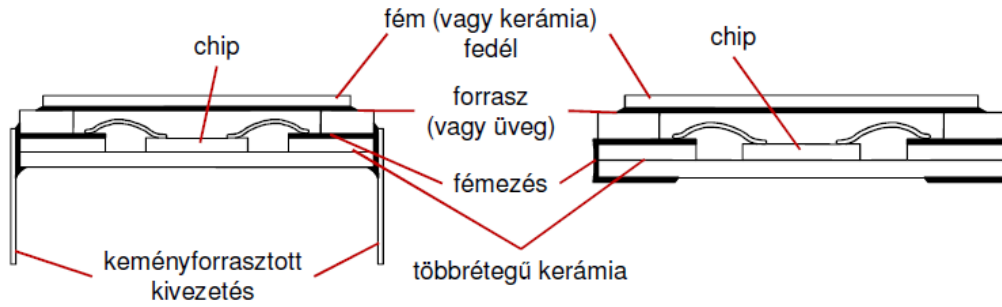

Fröcssajtolás

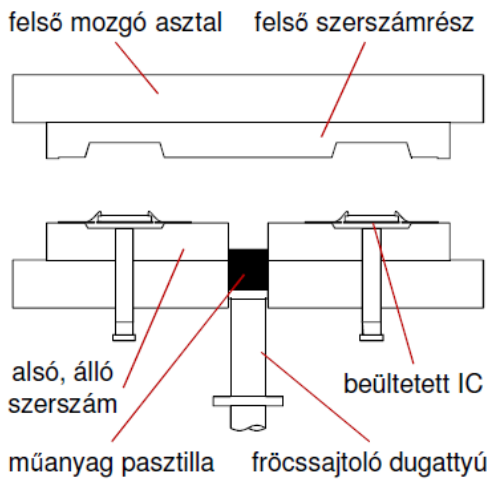

MBE

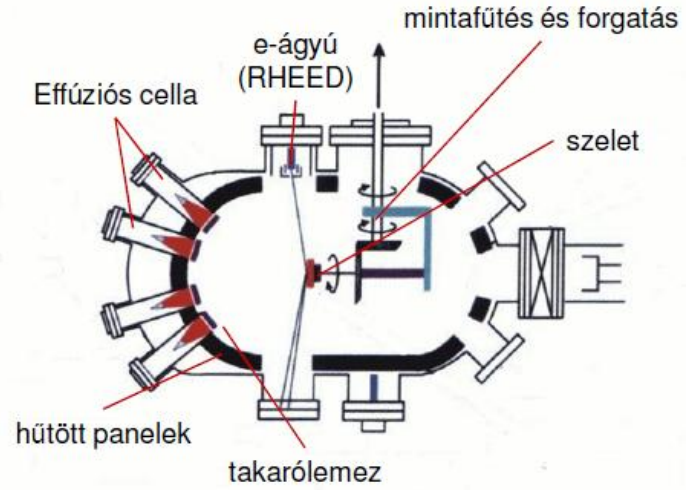

ionágyú

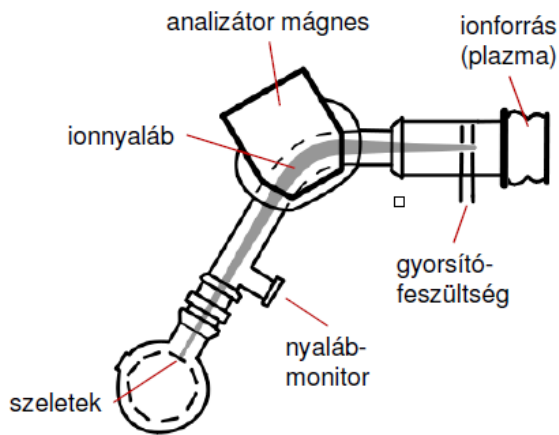

5.

Többrétegű lemez furatfajtái és rétegei

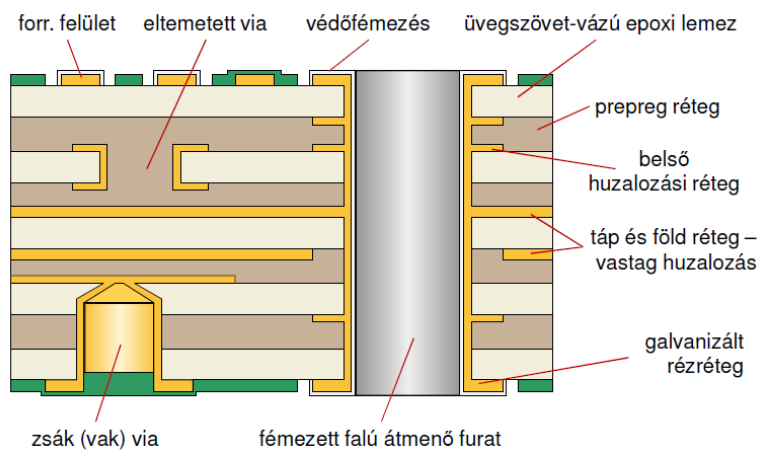

Biankó forma:

1.

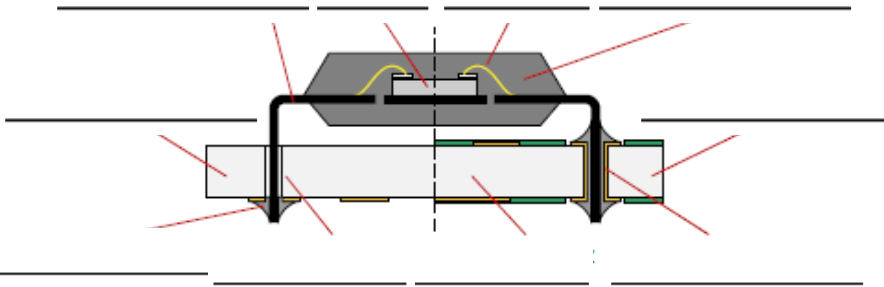

Ellenállás

Kondenzátor

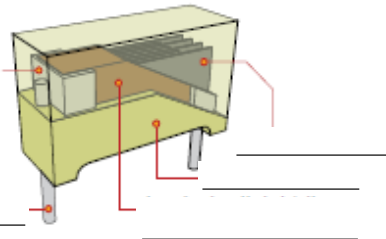
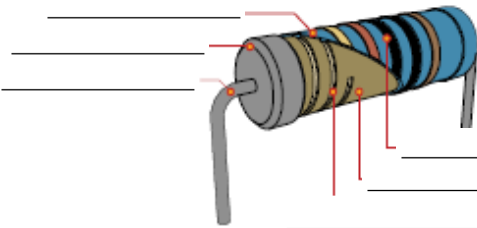

Tekercs

Dióda

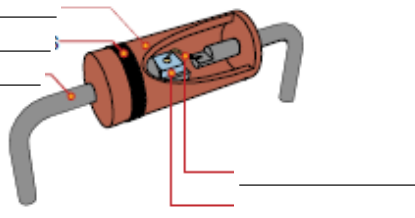
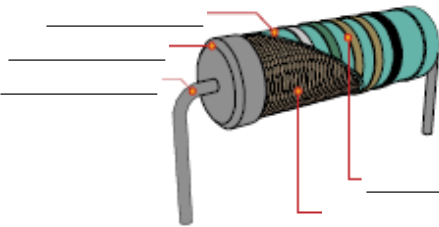

Felületszerelt kondenzátor

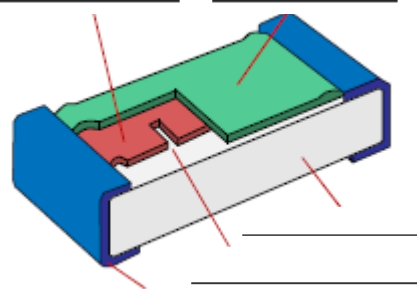
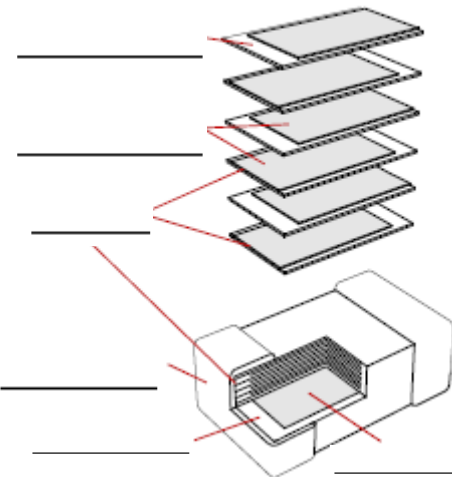

BGA

FC-BGA

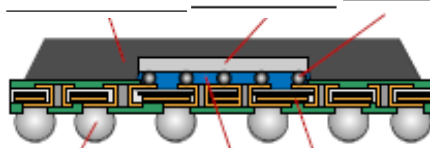
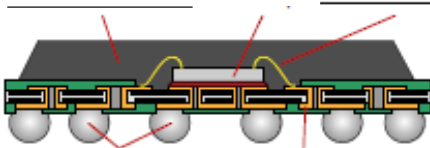

Idő/nyomás elvű

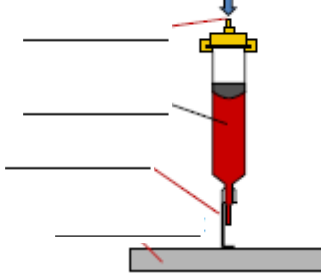

Csavarorsós

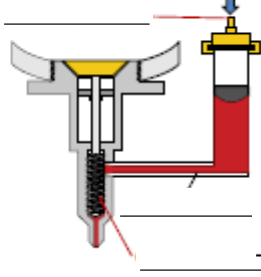

Sugaras csepppadagoló

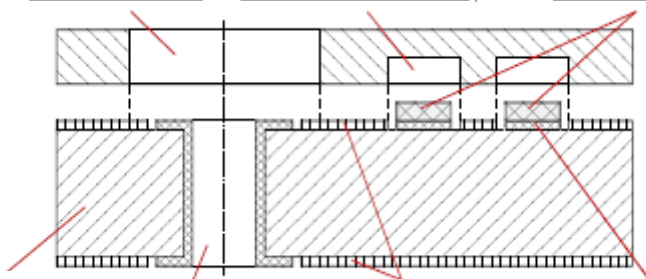
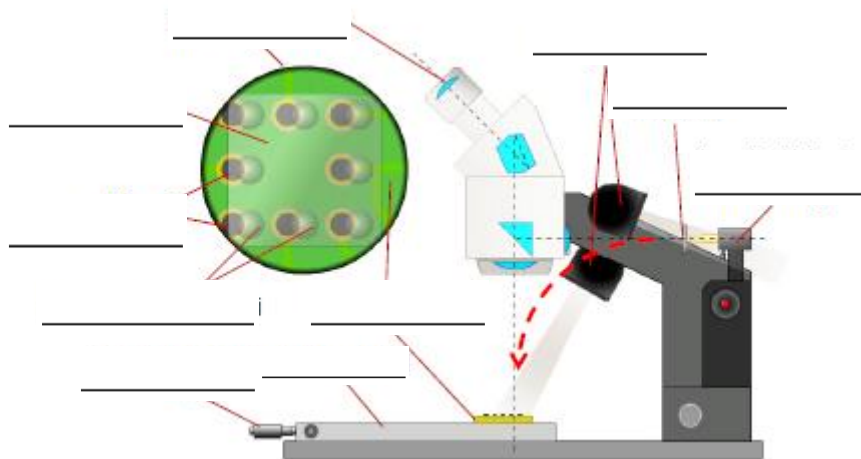
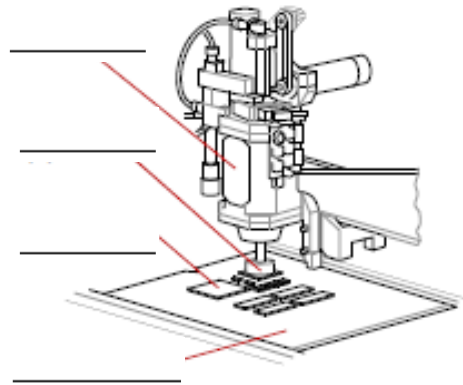
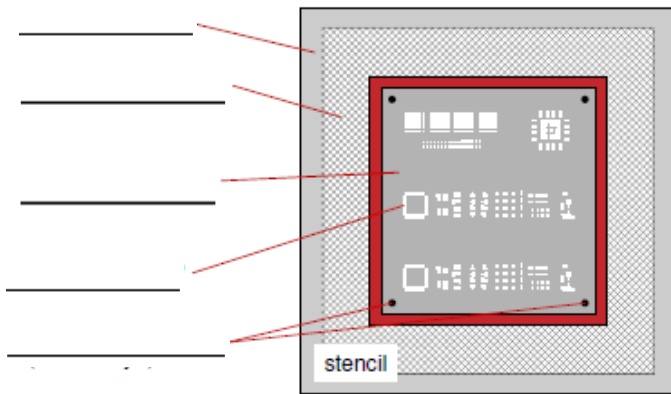
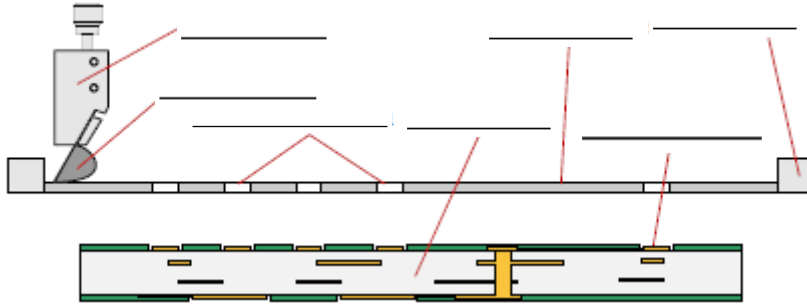
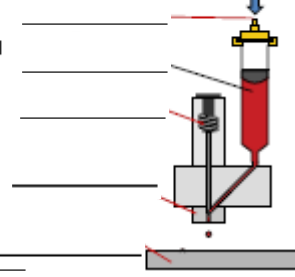

2.

Chip+huzalkötés (Chip-and-wire)

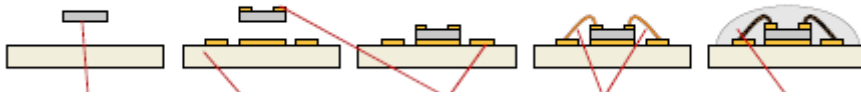

TAB (Tape Automated Bonding)

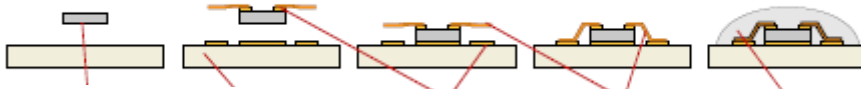

Flip-chip

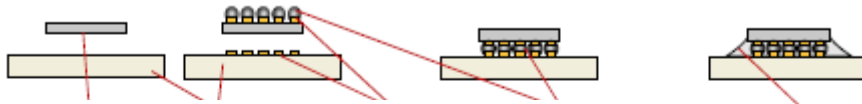

Tokozott chip

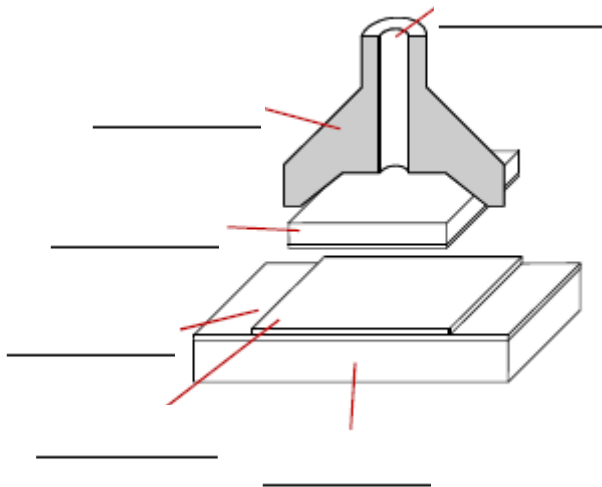
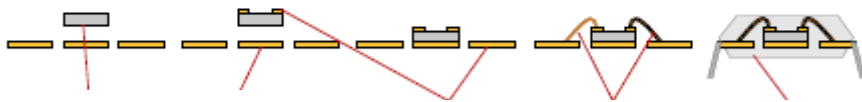

Fémüveg tok

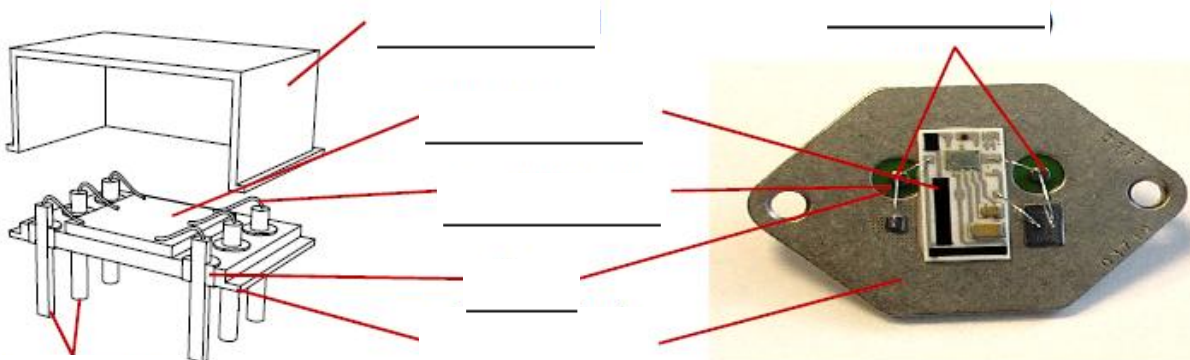

Kerámia tok

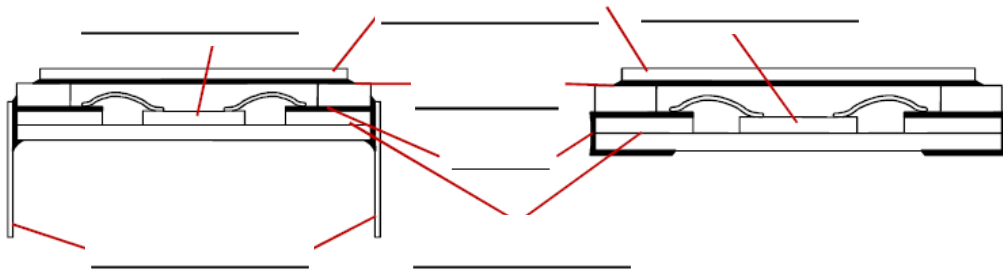

Fröcssajtolás

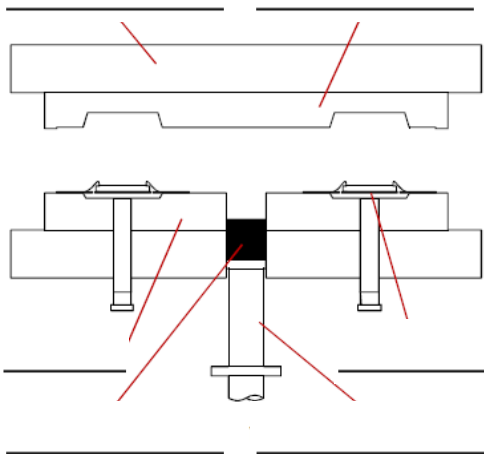

MBE

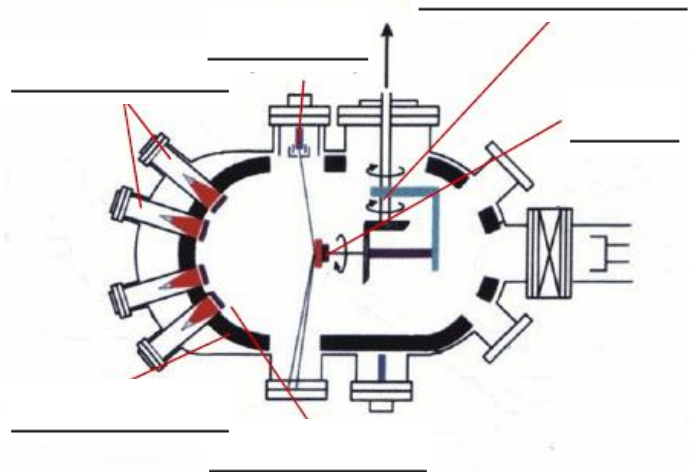

ionagyú

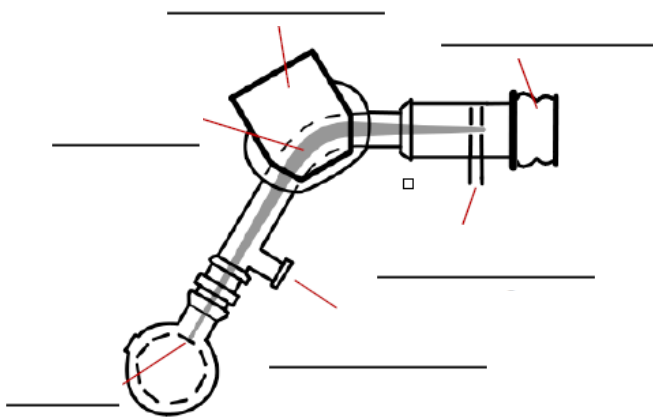

5.

Többrétegű lemez furatfajtái és rétegei

